



SMART10 A/Z

CONTINUOUS LINE OF LIGHT IN A SMALL OVERALL DIMENSIONS

CIĄGŁA LINIA ŚWIATŁA W MAŁYM GABARYCIE



- decorative and lighting profile
- continuous line of light (when using LED strip 120 P/m and white cover)
- SLICK socket
- miniature dimensions
- universal application
- the possibility of using waterproof LED strips
- maximum width of LED strip: 10 mm
- profil dekoracyjno-oświetleniowy
- ciągła linia światła (przy zastosowaniu taśmy 120 P/m i klosza mlecznego)
- gniazdo SLICK
- miniaturowe gabaryty
- uniwersalne zastosowanie
- możliwość zastosowania taśm wodoodpornych
- maksymalna szerokość taśmy LED: 10 mm



SIMILAR IN THE OFFER / PODOBNE W OFERCIE

SLIM8
A/Z

SMART-IN10
A/Z

SURFACE10
BC/UX

BEGTON12
J/S

SURFACE14
EF/TY

 TOPMET®

SMART10 A/Z

- A** slide cover
klosz A wsuwany
- Z**¹ Z flexible mounting plate
uchwyt Z sprężysty
- Z**² cone Z flexible mounting plate
uchwyt Z sprężysty cone

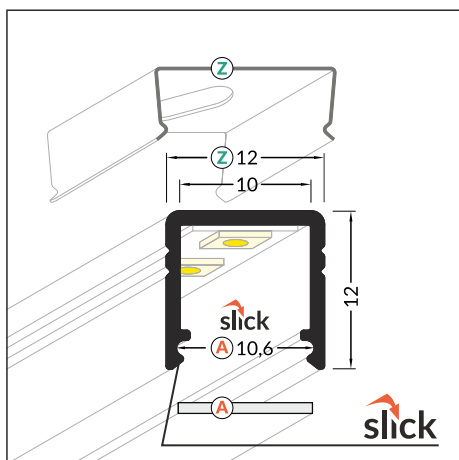
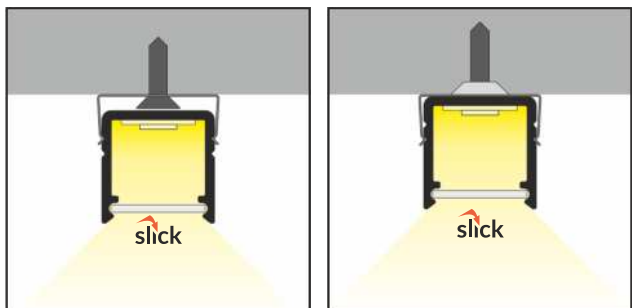
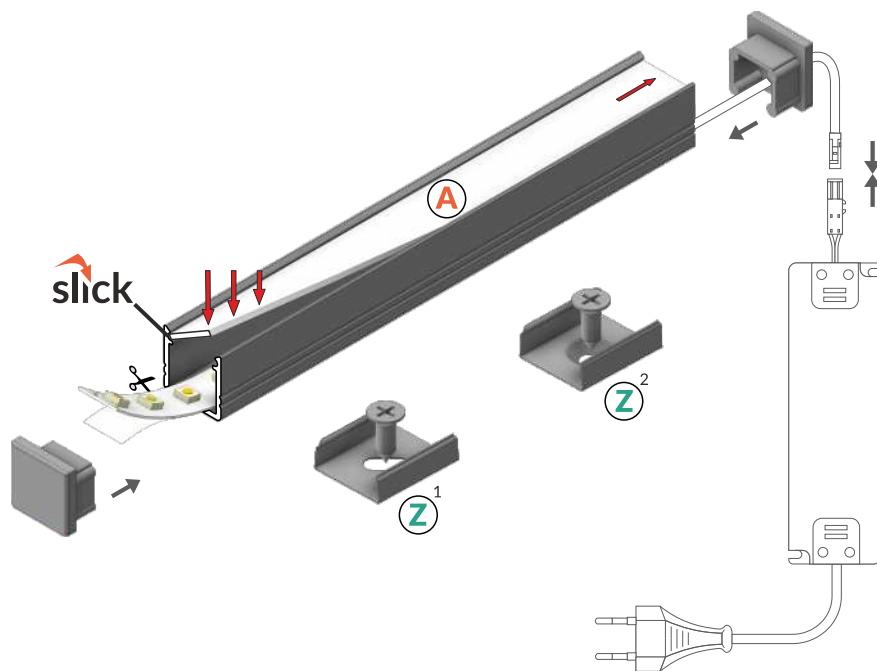

max 10 mm



surface
nawierzchniowy



INDEX = 1 pc, length 2000 mm
package = 10 pcs
INDEKS = 1 szt., długość 2000 mm
opakowanie = 10 szt.



white painted
biały malowany
C2020001



anodized
anodowany
C2020020



black anodized
czarny anodowany
C2020021



raw aluminium
surowe aluminium
C2020000

Available lengths / Dostępne długości
1000 mm, 2000 mm, 3000 mm, 4000 mm



COVERS / KLOSZE

A slide cover
colours: transparent, frosted, white
material: PC, PP, PP

klosz **A** wsuwany
kolory: transparentny, szron, mleczny
materiał: PC, PP, PP

Note! Dimensions of the space to install LED source
Uwaga! Wymiary przestrzeni do zamontowania źródła LED

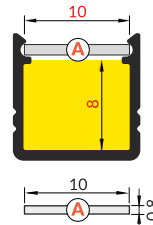

INDEX = 1 pc, length 2000 mm
package = 10 pcs
INDEKS = 1 szt., długość 2000 mm
opakowanie = 10 szt.

A transparent / A transparentny
89070016

A frosted / A szron
89070039

A white / A mleczny
89070038

ENDINGS / ZAŚLEPKI

SMART10 ending
colours: white, silver, black, grey
material: ABS

zaślepka SMART10
kolory: biały, srebrny, czarny, szary
materiał: ABS

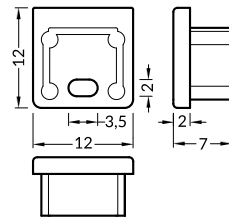

SMART10 ending with hole
colours: white, silver, black, grey
material: ABS

zaślepka SMART10 z otworem
kolory: biały, srebrny, czarny, szary
materiał: ABS

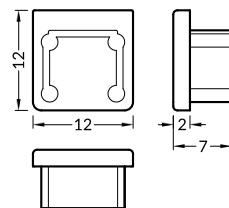

INDEX = 1 set
package of 10 sets = 20 pcs
INDEKS = 1 komplet, opakowanie
zawiera 10 kompletów = 20 szt.

white / białe
without hole bez otworu | with hole z otworem
C2940001 | C2960001

silver / srebrne
without hole bez otworu | with hole z otworem
C2940040 | C2960040

black / czarne
without hole bez otworu | with hole z otworem
C2940002 | C2960002

grey / szare
without hole bez otworu | with hole z otworem
C2940022 | C2960022

MOUNTINGS / MOCOWANIA

Z flexible mounting plate
colours: white, inox, black
material: stainless steel

uchwyt **Z** sprężysty
kolory: biały, inox, czarny
materiał: stal nierdzewna

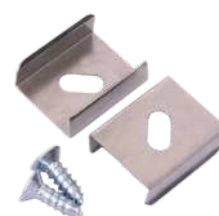
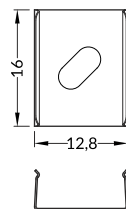
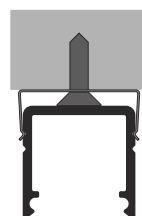

cone Z flexible mounting plate
colours: white, inox, black
material: stainless steel

uchwyt **Z** sprężysty cone
kolory: biały, inox, czarny
materiał: stal nierdzewna

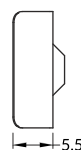
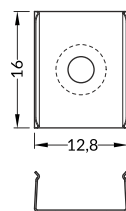
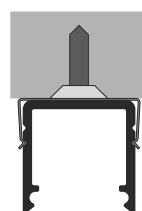

INDEX = 1 set
package of 10 sets = 20 pcs
INDEKS = 1 komplet
opakowanie zawiera 10 kpl = 20 szt.

Z flexible mounting plate
uchwyt **Z** sprężysty

white biały 89270001

inox inox 89270019

black czarny 89270002

cone Z flexible mounting plate
uchwyt **Z** sprężysty cone

white biały 89980001

inox inox 89980019

black czarny 89980002





CONNECTORS / ŁĄCZNIKI

SMART10 connector 90 deg
colours: white, anodized, black
material: aluminium

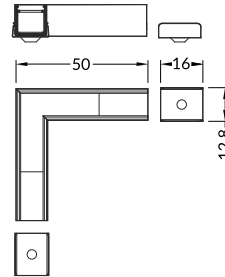
łącznik SMART10 90 st
kolory: biały, anodowany, czarny
materiał: aluminium



INDEX = 1 set
INDEKS = 1 komplet

-  white painted
biały malowany
C2910001
-  anodized
anodowany
C2910020
-  black anodized
czarny anodowany
C2910021



Made in Poland
Wyprodukowane w Polsce



EU-registered industrial design
Wzory przemysłowe EU

TOPMET LIGHT Kłósowicz Wiśniewski i Wspólnik Sp. j. ADDRESS: Ostrowska 354, 61-312 Poznań, POLAND
tel. +48 61 87 27 500, fax. +48 61 87 27 518 biuro@topmet.pl, www.topmet.pl

The catalogue is not an offer under Polish Civil Code regulations. Colours of particular products may vary slightly from colours shown in pictures. The dimensions given are approximate and can not be a reason for complaint. TOPMET Company reserves the right to make technical changes.
Folder nie stanowi oferty w myśl przepisów Kodeksu Cywilnego. Aktualną ofertę firmy stanowi cennik. Kolory poszczególnych produktów mogą się nieznacznie różnić od kolorów prezentowanych na zdjęciach. Podane wymiary są wymiarami orientacyjnymi i nie mogą stanowić podstawy reklamacji. Firma TOPMET zastrzega sobie prawo do wprowadzania zmian technicznych.

brochure designer • proj. folderu: M. Kędziora, A. Szafran 11.2016. photo • fot. A. Szafran, L. Wesołowski